

Overview

- Tension and compression load from 0 ... 5'000 N
- Non-linearity < 0.2 %
- One-sided stop with integrated hexagon for easy mounting
- Sensor body made of stainless steel with protection class IP68
- Fully welded sensor design
- Durable with 100% working stroke



Technical data

General data

Measuring range	0 ... 5000 N
Non-linearity	< 0.2 %
Repeatability	< 0.1 %
Temperature effect zero	< 0.2 % / 10K
Zero point deviation	< 20 %
Type	Inline
Mechanical mounting	M6 thread / M6 thread

Mechanical data

Overload	150 %
Breaking load	200 %
Fatigue strength	>10 Mio cycles at 0...100% FS
Nominal displacement	22 µm
Weight	55 g
Material sensor body	Stainless steel, 1.4542

Mechanical data

Electrical connection	M8, 4 pin, male
-----------------------	-----------------

Electrical data

Nominal sensitivity	1 mV/V
Bridge resistance	1000 Ω
Supply voltage	0.5 ... 12 VDC
Signal polarity positive	Tension

Environmental conditions

Operating temperature range	-40 ... 85 °C
Storage temperature range	-40 ... 85 °C
Protection class EN 60529, ISO20653	IP 68

Compliance and approvals

UL listed	E217824
-----------	---------

Dimensional drawings (mm)

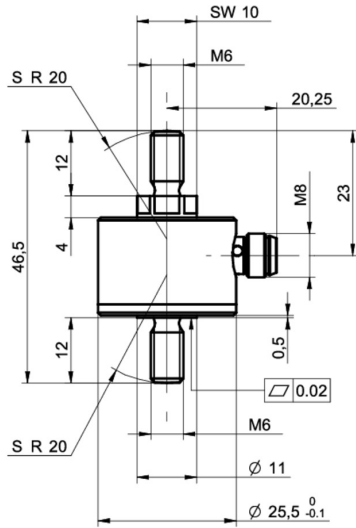

Electrical connection

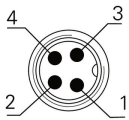

- 1 +Vs
- 2 Sig +
- 3 -Vs
- 4 Sig -