



Operating Manual

PA403
Prozess display

EN-US

Table of contents

| | |
|---|-----------|
| 1 About this document | 4 |
| 1.1 Purpose and scope of application | 4 |
| 1.2 Applicable documents | 4 |
| 1.3 Labels in this manual | 4 |
| 1.4 Warnings in this manual..... | 5 |
| 2 General functionality..... | 6 |
| 3 Mounting the process display..... | 7 |
| 4 Electrical connection of the process display | 8 |
| 4.1 Connection examples..... | 9 |
| 5 Interfaces | 11 |
| 5.1 LED indicator..... | 11 |
| 6 Operating functions | 13 |
| 6.1 Input signal configuration | 13 |
| 6.2 Configuration of the display..... | 14 |
| 6.3 Configuration of the limit value outputs | 17 |
| 6.4 Set limit values | 19 |
| 6.5 Protect programming level via code..... | 20 |

List of illustrations

| | | |
|--------|--|----|
| III. 1 | Block diagram of the configuration modules | 12 |
| III. 2 | Limit value outputs - Time delay | 17 |
| III. 3 | Limit value outputs - asymmetrical hysteresis..... | 17 |

1 About this document

1.1 Purpose and scope of application

This document enables safe and efficient sensor parameterization using various interfaces. The manual describes the available functions to support installation and software use via the interfaces.

The illustrations are examples only. Deviations are at the discretion of Baumer at all times. The manual is a supplementary document to the existing product documentation.

1.2 Applicable documents



- Available for download at www.baumer.com:
 - Data sheet
 - EU Declaration of Conformity
- Attached to product:
 - Quickstart
 - General information sheet (11042373)

1.3 Labels in this manual

| Identifier | Usage | Example |
|-----------------------|--|---|
| <i>Dialog element</i> | Indicates dialog elements. | Click the OK button. |
| <i>Unique name</i> | Indicates the names of products, files, etc. | <i>Internet Explorer</i> is not supported in any version. |
| Code | Indicates entries. | Enter the following IP address: 192.168.0.250 |

1.4 Warnings in this manual

Warnings draw attention to potential personal injury or material damage. The warnings in this manual indicate different hazard levels:

| Symbol | Warning term | Explanation |
|---|----------------|---|
|  | DANGER | Indicates an imminent potential danger with high risk of death or serious personal injury if not being avoided. |
| | WARNING | Indicates potential danger with medium risk of death or (serious) personal injury if not being avoided. |
| | CAUTION | Indicates a danger with low risk, which could lead to light or medium injury if not avoided. |
| | NOTE | Indicates a warning of material damage. |
|  | INFO | Indicates practical information and tips that enable optimal use of the devices. |

2 General functionality

The process display is intended for visualizing, monitoring, control and calculation of measured values in industrial applications.

- Voltage input up to 600V AC/DC
- Current input up to 5A AC/DC
- Display range can be linearized
- LED display, 4-digit, programmable
- DIN housing 96 x 48 mm

3 Mounting the process display

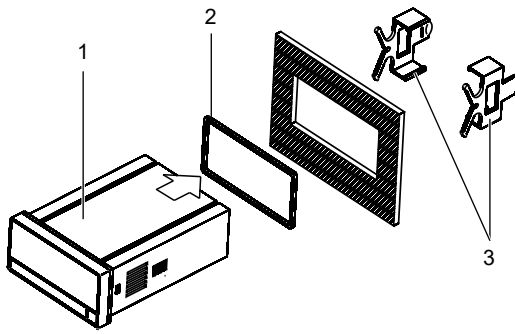

Instruction:

- a) Prepare the cut-out according to the dimensions.
- b) Push device (1) with seal (2) into the cut-out.
- c) Secure the device from behind using the clamping frame (3).
- d) Perform the electrical connection.

4 Electrical connection of the process display

Instruction:

- Make sure the device is disconnected from power supply and not live.
- Connect the device according to the pin assignment.

Pin assignment (at rear)

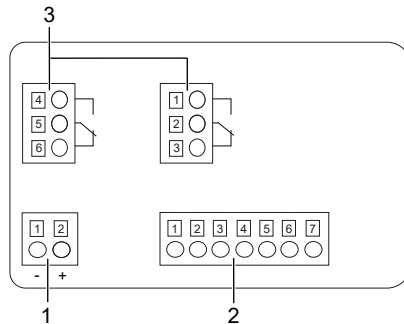

Operating voltage (1)

| Pin | VAC | VDC |
|-----|---------|-----|
| 1 | Phase | - |
| 2 | Neutral | + |

Input signal (2)

| Pin | Current/voltage |
|-----|--------------------|
| 1 | Common 0 V |
| 2 | Current max. 5 A |
| 3 | Current max. 1 A |
| 4 | Shunt max. 100 mV |
| 5 | Voltage max. 20 V |
| 6 | Voltage max. 200 V |
| 7 | Voltage max. 600 V |

Relay output (3), optional

| Pin | Two relays |
|-----|-------------------|
| 1 | normally closed 1 |
| 2 | Inverter 1 |
| 3 | normally open 1 |
| 4 | normally closed 2 |
| 5 | Inverter 2 |
| 6 | normally open 2 |

4.1 Connection examples

Input current

Connection direct:
range -1...+1 A DC and 0...+1 A AC

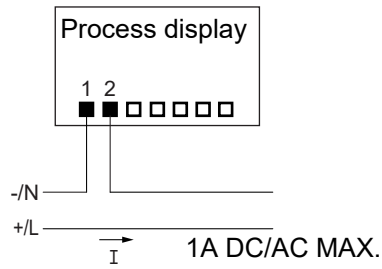

Connection via converter

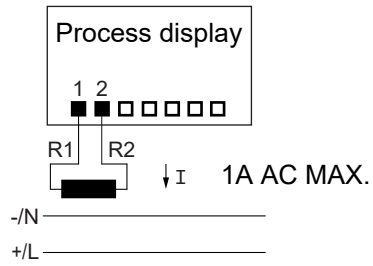

Connection direct:
range -5...+5 A DC and 0...+5 A AC

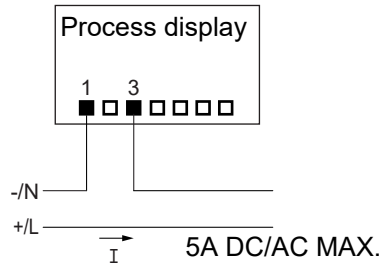

Connection via converter

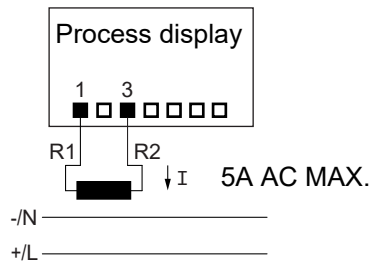

Input Shunt

Connection:
Range -100...+100 A DC and
0...+100 mV AC

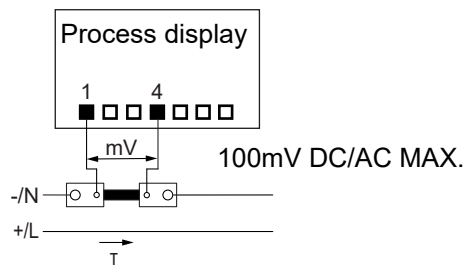

Input voltage

Connection:
Range -20...+20 V DC and
0...+20 V AC

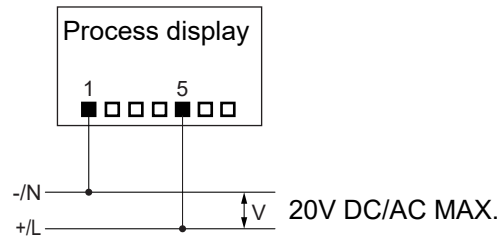

Connection:
Range -200...+200 V DC and
0...+200 V AC

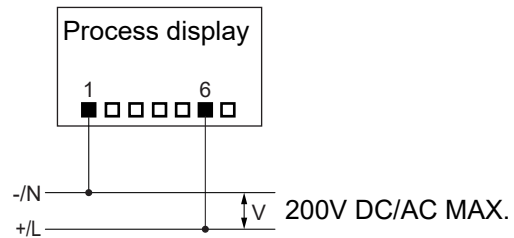

Connection:
Range -600...+600 V DC and
0...+600 V AC

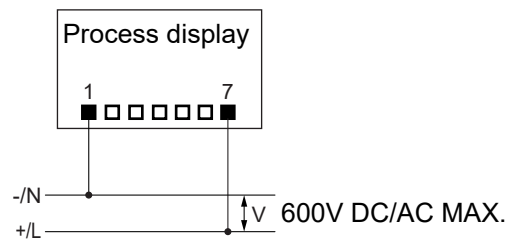

5 Interfaces

This section describes the interfaces via which you can communicate with the device.

All functions can be set directly on the device via the display and the membrane buttons.

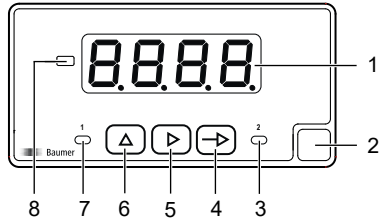

5.1 LED indicator

The device's LED display makes it easy to operate and monitor measured values.



After power on the device is in **RUN** mode. The current value (actual value) is displayed.

Mode **PROG** enables the entire device configuration.

| No. | Designation | Function in mode | |
|-----|--|--|------------------------------------|
| | | RUN | PROG |
| 1 | Display | 4-digit LED display | |
| 2 | Label | Position for unit sticker | |
| 3 | LED 2 | Output 2 active | |
| 4 | Button  | Call mode PROG | Programming line selection |
| 5 | Button  | MIN/MAX display | Digit/Function selection |
| 6 | Button  | – | Incrementing the selected digit |
| 7 | LED 1 | Output 1 active | |
| 8 | LED plus/minus sign | Enabled with negative displayed values | Enabled with negative input values |

Mode PROG (programming mode)

The programming mode allows the complete configuration of the process display. It comprises several configuration modules:

- Configuration input signal
- Display configuration
- Limit value output configuration *

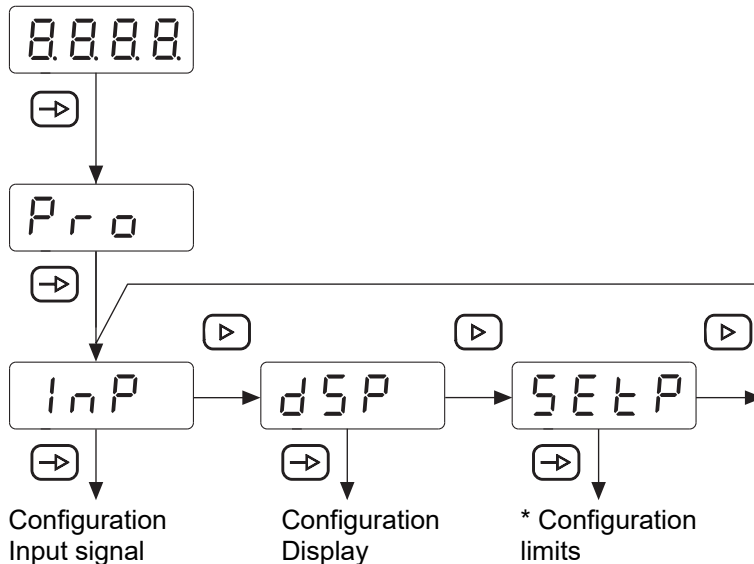

III. 1: Block diagram of the configuration modules

** As an option, according to product variant (see data sheet)

Programming procedure

Instruction:

- a) Press **→** to have **PrO** appear on the display as initial view of the programming level.
- b) Select the required configuration module with button **▶**. The individual modules provide short descriptions. (InP, dSP, etc.).
- c) Confirm selected module with **→** and start parameterization of the desired functions using buttons **→**, **▶** and **▲**. Having confirmed the final parameter, **PrO** appears again on the display. Press button **→** to select another configuration module or to exit the programming level.

Result:

- ✓ **Stor** appears briefly on the display and parameterization is being saved.



NOTICE

Access to programming can be blocked at programming level. The various programming lines can then only be visualized but not changed. When entering the programming level, **dAR** then appears instead of **PrO**.

6 Operating functions

6.1 Input signal configuration

This function is used to configure the input signal.

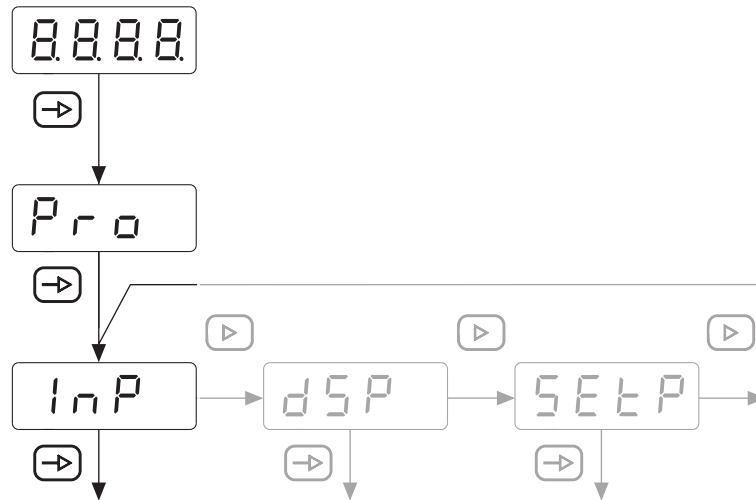

Configuration
Input signal

- Select the input signal type with I.
- DC voltage
 - AC voltage
 - VDC
 - VAC
- Confirm with .

Select voltage

- Select the voltage range with button .
- 600 V
 - 200 V
 - 20 V
- Confirm with .

Select current

- Select the currant range with button .
- 5 A
 - 1 A
 - Shunt 100 mA
 - Shunt 60 mA
- Confirm with .

6.2 Configuration of the display

This function is used to configure the representation of the input signal on the display.

Positive gradient:

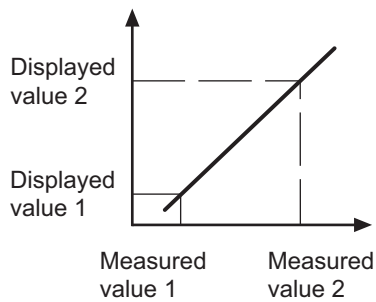

The scaling determines the relationship between the input signal and the display value. For linear behavior, two measured values (*inP*) or display values (*dSP*) must be defined. To achieve the best precision, these 2 points should be selected at both ends of the display range.

Negative gradient:

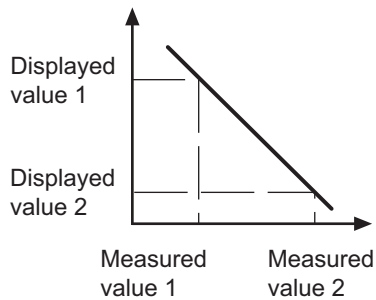

The coordinates of these two points can be entered directly using the keypad (scaling mode) or the measured values are automatically adopted. Only the assigned display values need to be entered via the keypad (teach mode).

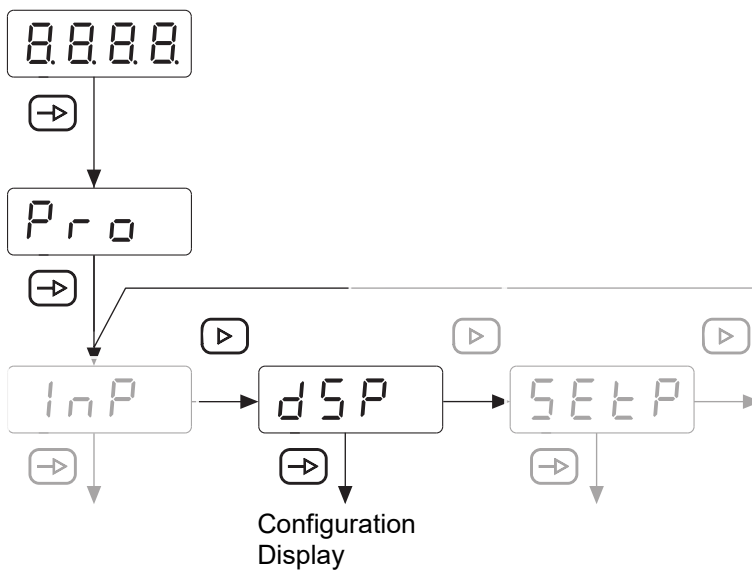

INFO

Only the configuration parameters for the selected input signal can be selected.

`dSP` Select the mode with button .

`CR L` Calibration mode

`USE r` Display range

Confirm with .

Select the parameter to be configured with button .

`SCAL` Scaling mode (teach-in using known support points)

`TEEC` Teach mode (teach-in using measured support points)

`F, LL` Display stabilization filter

Confirm with .

Scaling mode (teach-in using known support points)

Configuration of input and display values is done manually using the soft-touch keypad at the process display. This method is appropriate if the sensor-supplied signal values are known at each extreme point of the process.

`SCAL`

`INP 1` First measured value

`0000` Input range at soft-touch keypad from -9999 to 9999

`dSP 1` Display value for the first measured value

`0000` The value entered here will be displayed upon the input signal reaching the first measured value. Ranging from -9999 to 9999

`000.0` Decimal point dSP1

Positioning decimal point, applies to dSP1 and dSP2.

`INP 2` Second measured value

`0000` Keypad entries from -9999 to 9999.

`dSP 2` Display value for the second measured value

`0000` The value entered here will be displayed upon the input signal reaching the second measured value. Ranging from -9999 to 9999

Teach mode (teach-in using measured support points)

The input values are read directly at the input at the time the signal is detected at any point in the process. Displayed value configuration is done manually using the soft-touch keypad of the process display. This method is appropriate if the signal values are known at each point but running the process at the conditions defined by these extreme points is not feasible.

TEACH

INP1 First measured value

0000 The input signal value is automatically adopted.

dSP1 Display value for the first measured value

0000 The value entered here will be displayed upon the input signal reaching the first measured value. Ranging from -19999 to 199999

000.0 Decimal point dSP1

Positioning decimal point, applies to dSP1 and dSP2.

INP2 Second measured value

0000 The input signal value is automatically adopted.

dSP2 Display value for the second measured value

0000 The value entered here will be displayed upon the input signal reaching the second measured value. Ranging from -19999 to 199999

Display stabilization filter

Defines the limit frequency of the low-pass filter (F_c) applied to smoothen unwanted display fluctuations.

FILT

0 Programmable from 0 to 9 with the button .

Increasing the filter value reduces the response time of the display. The value 0 deactivates the filter.

Confirm with .

6.3 Configuration of the limit value outputs

The device has a relay limit value output. Programming *High*, *Low* or *HighLow* can be used to determine whether the outputs are activated when the display value is \geq or \leq the limit value. The outputs can be programmed with a time delay or with a hysteresis.

Time delay of the limit value outputs

The time delay is programmable from 0 to 99 s. This acts both when the limit value outputs are switched on and off.

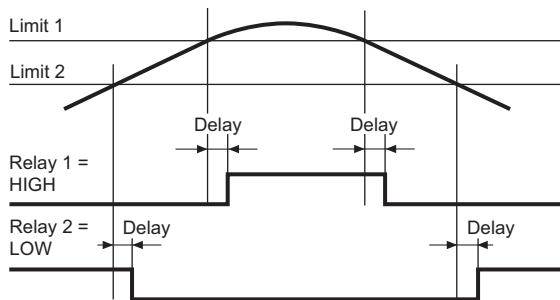

III. 2: Limit value outputs - Time delay



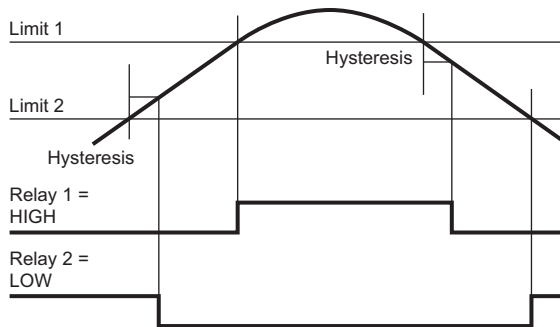

Asymmetric hysteresis

The hysteresis is programmed in display units from 0 to 9999. This only takes effect when the limit value outputs are switched off.

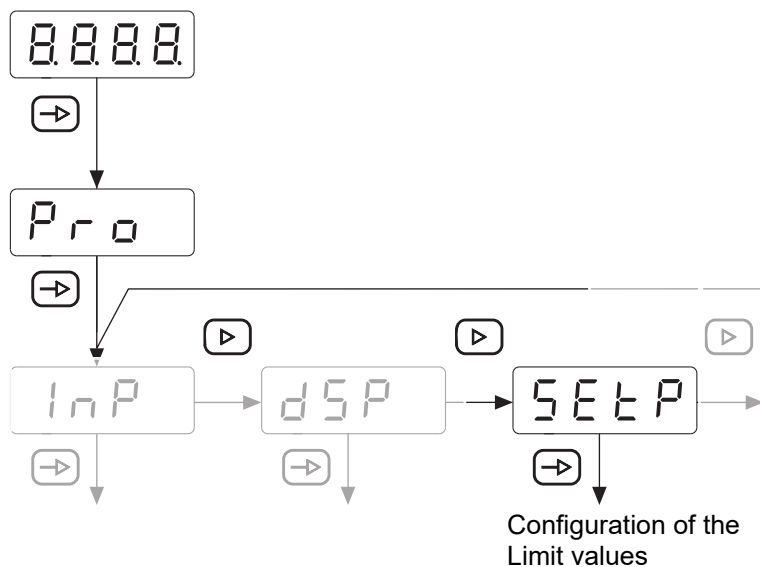



III. 3: Limit value outputs - asymmetrical hysteresis



- SEtP** Select the input signal value with button .
- SEt1** Limit 1
- SEt2** Limit 2
- Confirm with .
- SEt1** Select the input signal value with button .
- Hi** HIGH = Enabled at display value \geq limit
- Lo** LOW = Enabled at display value \leq limit
- Confirm with .
- 0000** Value programmable from -9999 to 9999.
-

Relay output in idle state

- Select the input signal value with button .
- no** Normally open
- nc** Normally closed
- Confirm with .
-











Function of the relay output

- dLY** Time delay
- HYS** Hysteresis
- 0000** Delay or hysteresis value
- Programming the delay (dLY) from 0 to 99 s or hysteresis (HYS) from 0 to 9999 display units.
- SEt2** Configuration is in an analog way to [Set1].

6.4 Set limit values



Programming is independent of the configuration module programming and can be executed any time.

You are in mode **RUN**.

1. Press button  .
Pro] appears on the display to get you started with programming.
2. Select the first limit with button  .
-  3. Change the limit using button  and  .
4. Press button  to go to the next limit.
-  5. Change the limit using button  and  .
6. Press the  button to save the values and exit programming mode.
 The value is saved and you are back in **RUN** mode.



NOTICE

It is possible to lock/unlock the keypad to prevent the setpoint from being changed. Press the button , the message [CodE] is displayed. Press the  button for 5 seconds to call up the lock/unlock menu.





6.5 Protect programming level via code

The programming can be protected against unwanted changes by a code:

- **Complete**
 - All configuration modules are protected. The various configuration modules can be visualized but not edited.
 - When entering programming mode, [DAtA] is displayed instead of [Pro].
- **Partial**
 - You can select which configuration modules are to be protected. The protected configuration modules can be visualized but not changed.
 - When entering programming mode, [DAtA] is displayed instead of [Pro] if a protected configuration module is selected.

Enter or change code

Instruction:

- a) Press the button  for 3 seconds.
 - ✓ [CodE] appears in the display.
- b) Enter the code by pressing  and . The factory-set code on delivery of the device is 0000.
- c) Use button  to switch to and fro between the functions described below. Select the desired function with button .

 Selecting [List] you can define in the following lines which configuration modules are protected by code against unauthorized access.

 Change code

Configuration module protection



 All locked

 No, the various configuration modules can be individually protected.

In the next step, here is to specify which configuration module is protected by 0 or 1 or not protected at all.

- no: configuration module not protected
- yes: configuration module protected

 Yes, all configuration modules are protected against modification and device exits the programming level.

Change code



 Change the code here, the new code is saved into the device and you exit programming level.

