

**Overview**

- measuring mode: edges, center, width
- 30 mm
- 50 mm
- pulsed infrared diode
- Teach-in
- connector M12 8 pin, rotatable
- 55 °C
- IP 67



Picture similar



**Technical data**

**General data**

Type	Measuring mode: edges, center, width
Version	With filter for transparent objects
Measuring field size	30 mm
Measuring distance (to object)	50 mm
Measuring frequency	500 Hz
Resolution	< 0.03 mm
Smallest object recognizable	0.3 mm
Linearity error relative	< 0.3 %
Light source	Pulsed infrared diode
Wave length	880 nm
Adjustment	Teach-in

**Electrical data**

Response time	< 2 ms
Voltage supply range +Vs	15 ... 28 VDC
Current consumption max. (no load)	150 mA

**Electrical data**

Output signal	4 ... 20 mA
Switching output	NPN
Output function	Out 1 / Out 2
Output current	< 100 mA
Interface	Analog and RS485
Baud rate	19200, adjustable
Reverse polarity protection	Yes, Vs to GND

**Mechanical data**

Width / diameter	23 mm
Type	Rectangular
Housing material	Die-cast zinc
Front (optics)	Glass
Connection types	Connector M12 8 pin, rotatable

**Ambient conditions**

Operating temperature	0 ... +55 °C
Protection class	IP 67

**Dimension drawing**

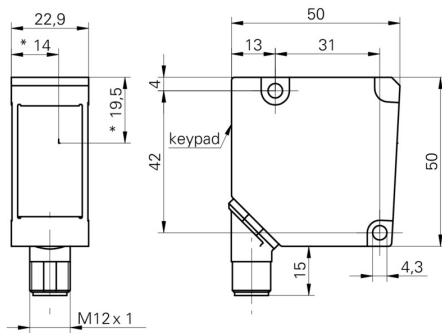

- \* receiver axis

**Connection diagram**

